

NOTES:

- 1) FOR INFORMATION ON CONNECTIONS AND PRODUCT SPECIFICATIONS, PLEASE REFER TO HANDBOOK, PRODUCT SUPPORT AND WORKSHOP MANUALS.
- 2) FOR ANY DIMENSIONAL INFORMATION NOT INCLUDED PLEASE CONTACT YOUR SALES REPRESENTATIVE.
- 3) DIMENSIONS SHOWN ARE ACTUAL PRODUCT SIZE AND DO NOT INCLUDE ANY CLEARANCE DATA.

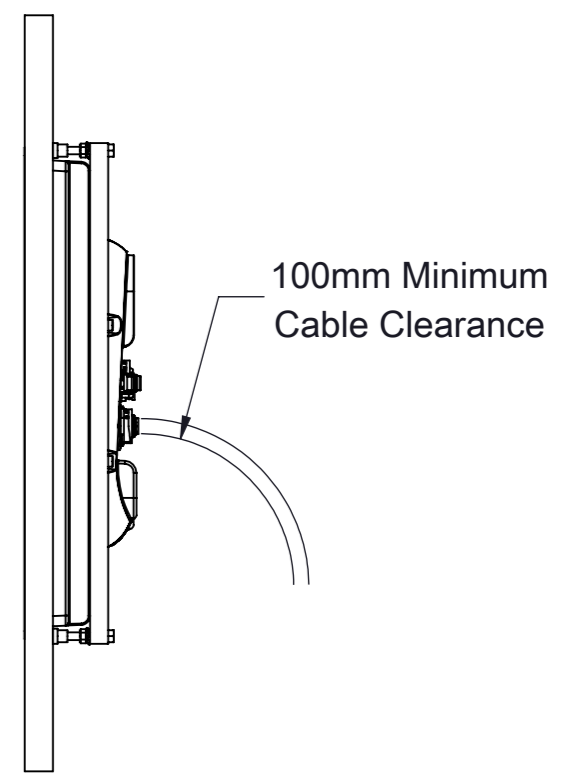
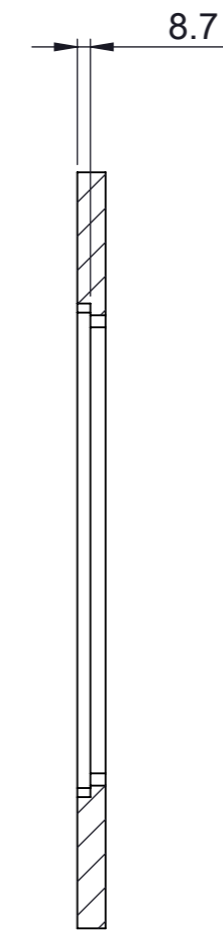
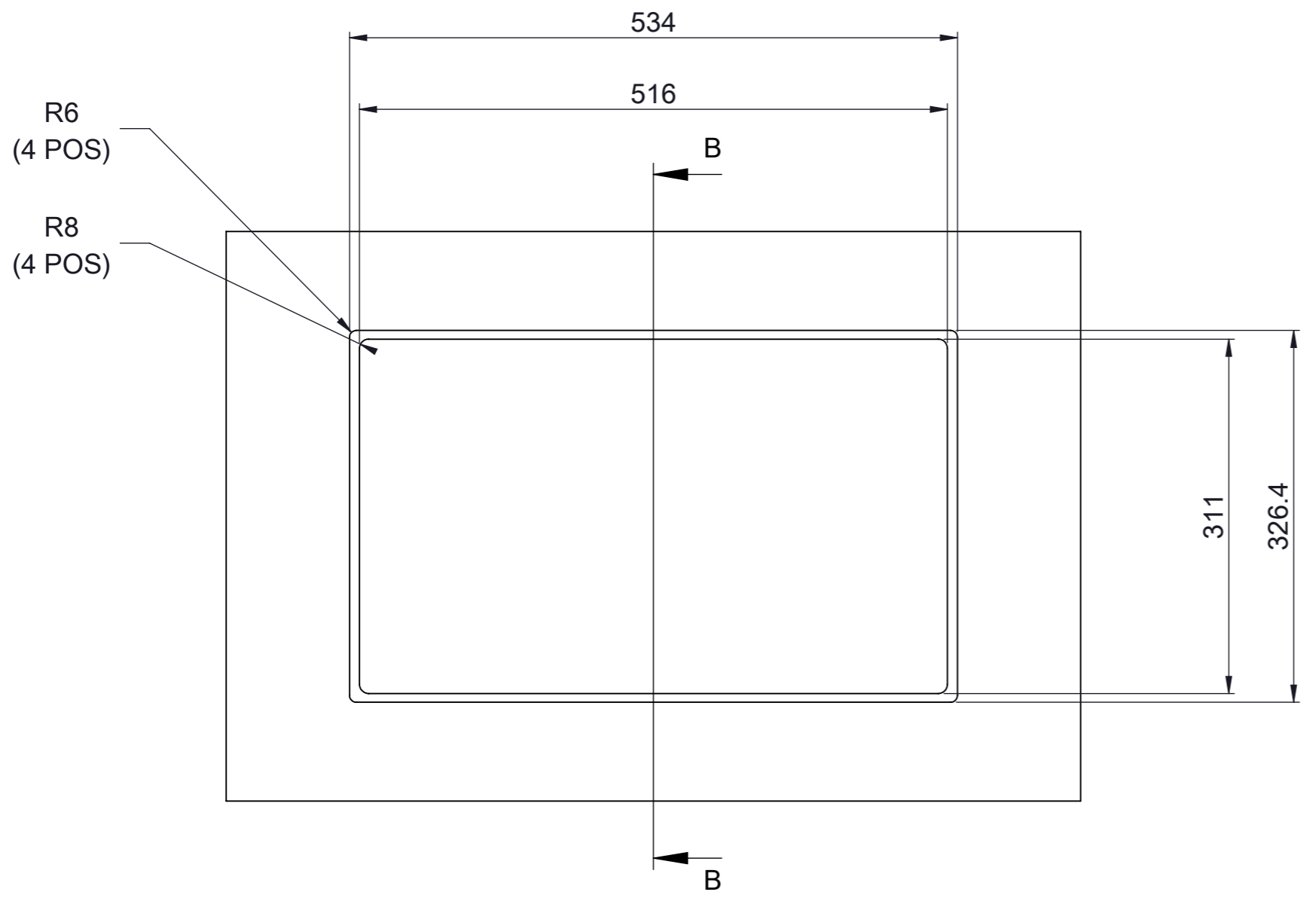
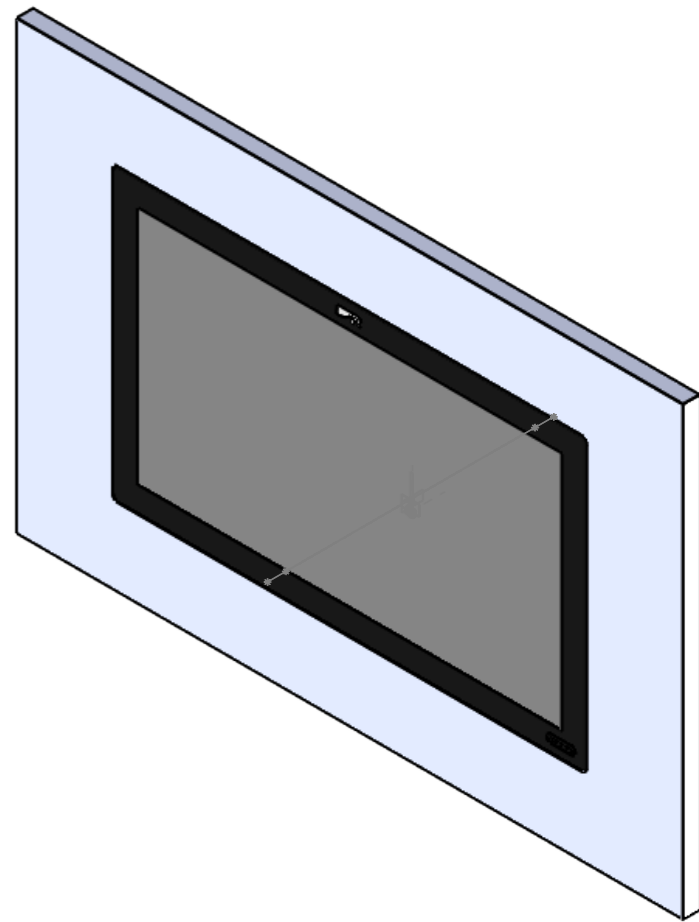

SECTION B-B

Raymarine

© 2019 RAYMARINE LTD
Company Confidential

THE INFORMATION CONTAINED HEREIN SHALL NOT BE REPRODUCED WITHOUT THE PRIOR WRITTEN PERMISSION OF RAYMARINE LTD

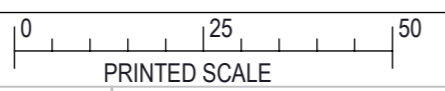

DRAWN TO BS308

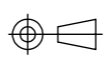

DO NOT SCALE - IF IN DOUBT ASK

DRN:	MA
DIMENSIONS IN MM	

DATE: 2023-06-15
SCALE: 1:5

TITLE **D_AXIOM2XL22_FM**

DRAWING No. **D_AXIOM2XL22_FM**