



48V BATTERY MANUAL

Models: 60Ah / 120 Ah / 210Ah



Contents

Introduction	2
Features	2
What’s in the box.....	3
Safety	3
Installation	3
Operation	3
Emergency.....	3
What do I need for installation?.....	4
How to use Bluetooth to Monitor your Batteries using your Smart Phone.....	5
How to Properly Size Cables for System	6
How to Incorporate Fuses into the System.....	6
How to Properly Charge the Batteries	7
Charging Logic.....	7
Discharging Specification.....	8
How does the BMS protect the batteries?	8
How to Properly Store Batteries	9
How to Maintain the Batteries	10
Inspection	10
Cleaning.....	10
Checking Voltage.....	10
How to Properly Recycle and Dispose of the Batteries.....	11
Limited Warranty.....	11
Return Policy.....	11
Customer Service.....	11
Return Shipping.....	11
Product Specifications	12
Mechanical Specifications.....	13

Introduction

Solid State Marine (SSM) 48V Series Deep Cycle Marine Battery are designed for the drop-in replacement of deep-cycle lead-acid and lithium batteries with its standard Battery Council International (BCI).

Weighing almost half as much as a Lithium Iron Phosphate (LFP) battery and a quarter of lead-acid counterparts, our battery has more power, lighter weight, and can be safely discharged to 100% Depth of Discharge (DOD). Manufactured with high grade solid state flat battery cells and featuring an advanced Battery Management System (BMS) that provides comprehensive protection to the battery.

Features

Solid State Marine (SSM) 48V Series Deep Cycle Marine Battery features a greater energy density, a deeper discharge capability, and a faster charging speed in a smaller size than any other battery in the market.

- **More Power / Less Weight:** Our battery technology offers the highest energy density of any commercial battery available: up to 100Wh per lb. This means our Group 27 batteries offer over 3kWh and our Group 8D batteries offer over 10kWh.
- **Greater Safety:** Solid state design is safer than Lithium / LFP or AGM batteries as the electrolyte is a solid and non-combustible.
- **Superior Temperature Performance:** Operates down to -4°F and up to 150°F
- **Bluetooth:** IOS and Android Apps control and monitor battery functions such as State of Charge.
- **Uncompromising Quality:** Our battery lifespan ensures more than 3000 cycles (80% DOD), a continuous charge current of up to 150A, and a continuous discharge current of 500A for our 48V UHP battery. We operate over the widest temperature range including cold weather.
- **Reliable BMS Protection Mechanisms:** Designed to withstand the extremes of marine boating, RV, and golf cart use, and includes multiple levels of protection such as low temperature cut-off and precise balancing through the smart battery management system.

What's in the box

Solid State Marine Deep Cycle
Low Temperature Battery (1)



Startup guide (1)

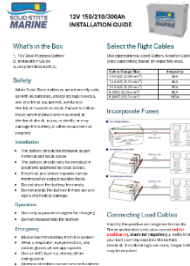

Insulating Sleeve (2)

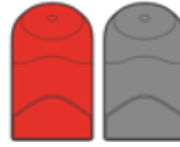

Long Terminal Bolt (2)

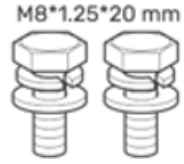

Safety

While Solid State batteries are inherently safe, as with all batteries, energy storage devices, and electrical equipment, safety and electrical hazards do exist. Failure to follow these safety instructions may result in electrical shock, injury, or death, or may damage the battery or other equipment or property.

Installation

- The battery should be installed as per national and local codes
- The battery should only be installed in locations approved by local building codes.
- Electrical and shock hazards can be minimized by covering the solar array and using insulated tools.
- Do not short the battery terminals.
- Do not install the battery if there are any signs of physical damage
- Do not install the battery in a location that may be flooded.

Operation

- Use only approved battery chargers for charging the battery.
- Do not disassemble the battery.
- A CSL is required for use with inverters 3500W or higher.

Emergency

- Disconnect the battery from the system.
- Wear a respirator, eye protection, and rubber gloves where appropriate.
- Use an ABC type dry chemical fire extinguisher.
- Dispose battery as per local regulations.

⚠ **WARNING** ⚠

- Do not short battery terminal.
- Do not reverse polarity.
- Do not pierce battery casing.
- Do not attempt to disassemble.
- Do not drop or mishandle.
- Do not immerse in water.
- Do not operate with loose connections.
- Do not operate battery in series or in parallel with any other type of battery.
- Do not connect more than two batteries in series.
- Do not operate using cables that cannot accommodate the maximum current that can be delivered by the batteries (Please contact technical support to verify that you are using appropriate cables and contacts.)

What do I need for installation?



Wrench (9/16 in)



Battery Adapter Cables x 2

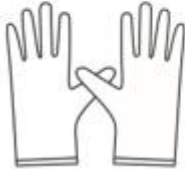

Insulating Gloves



Multimeter

Connecting Load Cables and Turn-On Batteries

1. Identify the positive and negative terminals. These are labeled and color-coded **red for positive (+)**, **black for negative (-)**.
2. Determine which finishing hardware set you will use. Verify that your bolt can fully seat into the battery terminal. If multiple lugs are used, longer bolts may be required for the bolt to fully seat into battery terminal.
3. When connecting to your battery terminals, **DO NOT** finger tighten. Use a torque wrench to torque your hardware to the specification of 9 to 11 ft-lbs. Failure to adequately secure connections can result in severe damage and will void your warranty. Fig. 2 below demonstrates proper and improper connections.

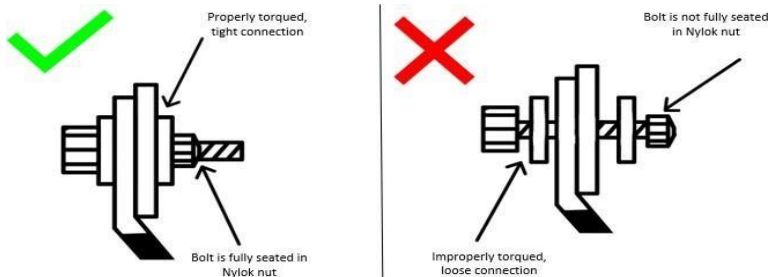
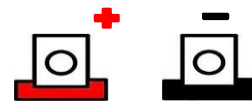

4. **BATTERIES TURN ON AUTOMATICALLY WHEN LOAD IS APPLIED.** Turn on your charger or load that battery is connected to.

How to use Bluetooth Monitor

1. Download the BMS APP on your IOS or Android Smart Phone

Apple IOS Search:

SSM BATTERY MONITOR HP

Android App search:

SSM BATTERY MONITOR HP

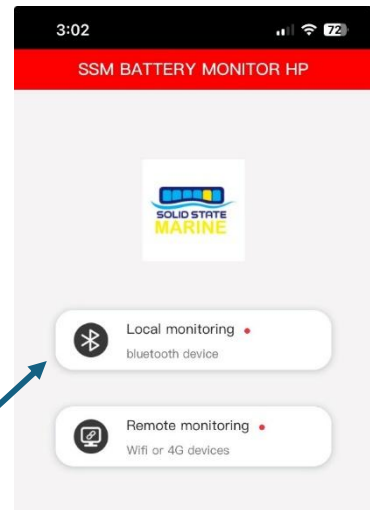

2. Open the SSM Battery Monitor Application > Select local monitoring

3. Select > Parallel to see a list of batteries available to Bluetooth.

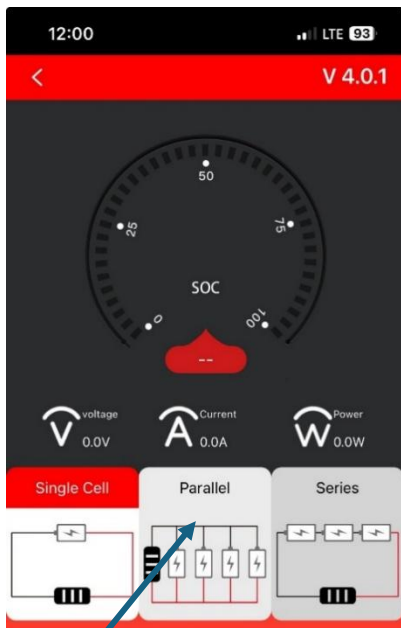

5. Return to the previous screen

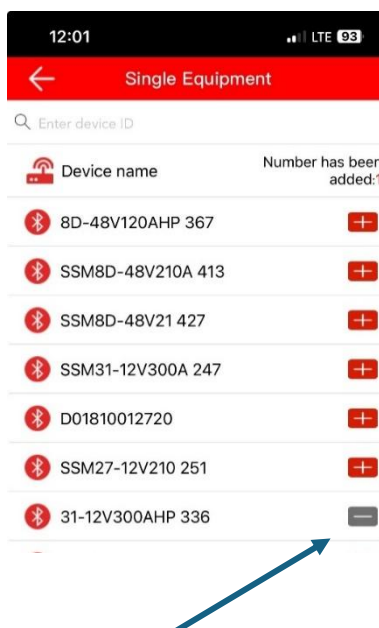

4. Select the battery you wish to monitor

7. You should now see state of charge.

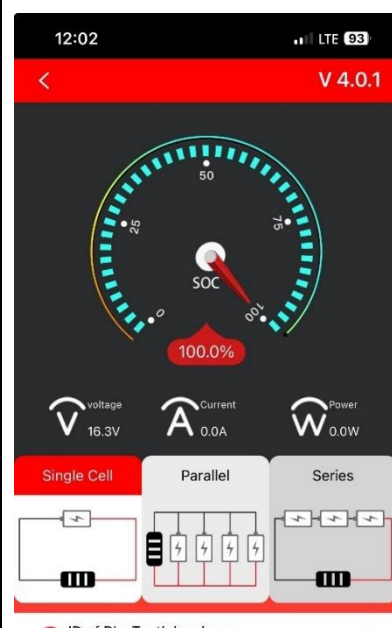

6. Select the battery again to see additional parameters

How to Properly Size Cables for System

Use appropriately sized Battery Adapter Cables (sold separately) based on expected load. Refer to the table below for copper cable ampacities with different gauge sizes.

Cable Gauge Size	Ampacity	Cable Gauge Size	Ampacity
14 AWG (2.08 mm ²)	35A	2 AWG (33.6 mm ²)	190A
12 AWG (3.31 mm ²)	40A	1 AWG (42.4 mm ²)	220A
10 AWG (5.25 mm ²)	55A	1/0 AWG (53.5 mm ²)	260A
8 AWG (8.36 mm ²)	80A	2/0 AWG (67.4 mm ²)	300A
6 AWG (13.3 mm ²)	105A	4/0 AWG (107 mm ²)	405A

How to Incorporate Fuses into the System

■ For a Single Battery

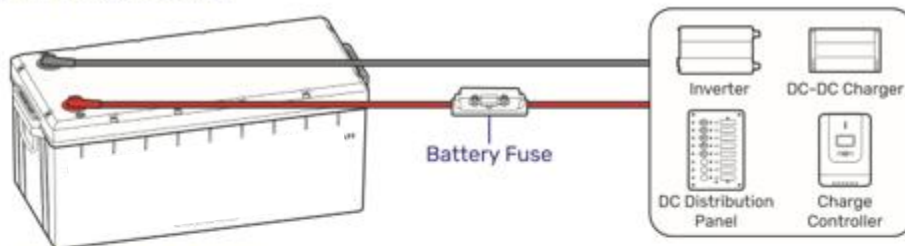

■ For Batteries in Parallel

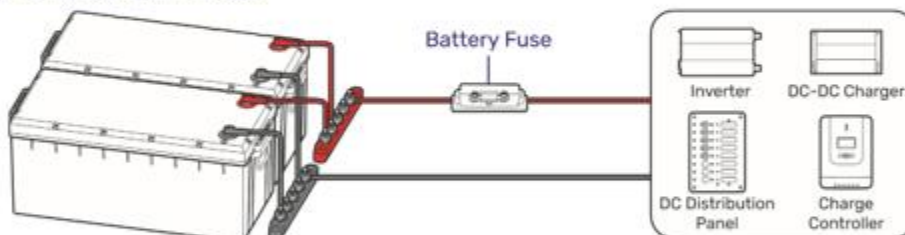

■ For Batteries in Series

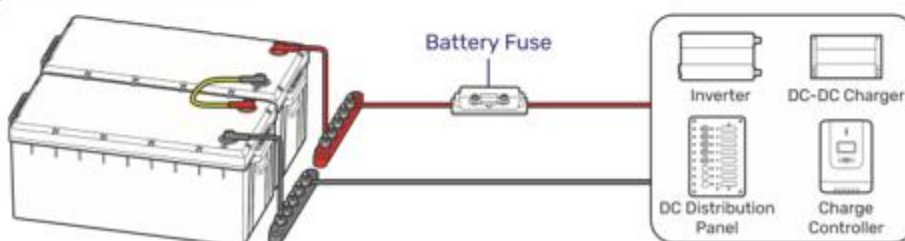

How to Properly Charge the Batteries

The battery will be received at a partial state of charge (SOC) depending on the time between manufacturing and shipping. It is crucial to fully charge the battery before its initial use. In case the battery shuts off due to low SOC, promptly disconnect it from loads and charge it to prevent irreversible damage. Follow the instructions in this user manual for proper charging and usage to ensure optimal battery performance and longevity.

Charging Logic

The standard charging process for the battery involves charging at a constant current until the battery voltage reaches 58.1 V for our 48 V battery, followed by charging at a constant voltage of 58.1 V while tapering the charge current to the tail current. Use the lithium battery setting on your charger.

When using a 20A charger, the charging process typically takes 3 hours for the 60 Ah, and 6 hours for the 120 Ah battery. Battery temperatures must be between -4°F and 150°F (-20°C and 65°C) for safe charging. Leaving the battery on will continue to balance the battery cells without damaging the battery.

Model	SSM27 – 48V60Ah	SSM8D - 48V120Ah	SSM8D – 48V210Ah
Charge Voltage	58.1	58.1	58.1
Quick Charge Current: Charge to 58.1 V constant current (CC) and then charge to the degree to which the charging current is less than tail current at constant voltage (CV)	60 A Then 1A	120 A Then 2 A	210 A Then 3.5 A
Standard Charge Current: Charge to 58.1 V at a constant current of 30A and then charge to the degree to which the charging current is less than tail current at constant voltage (CV)	20 A Then 1A	20 A Then 2 A	30 A Then 3.5A
Disconnect Charge Current' (BMS will disconnect if exceeded for 30 sec)	90 A	240 A	420 A
Tail Current	1 A	2 A	3.5 A
Over Voltage Protection	58.8 V	58.8 V	58.8 V
Over Voltage Reconnect	Automatically at 58 V	Automatically at 58 V	Automatically at 58 V
Temperature Compensation Required	None	None	None

Discharge Specification

Model	SSM27 - 48V60Ah	SSM8D - 48V120Ah	SSM8D - 48V210Ah
Continuous Discharge Current	60 A	120 A	210Ah
Peak Over Current (60 sec)	150 A	240 A	500 A
Short Circuit Protection (2msec)	1000A	1000 A	1000 A
Low Voltage Protection	35.28 V	35.28 V	35.28 V
Permanent Off Voltage	35 V	35 V	35 V

How does the BMS protect the batteries?

The battery is equipped with a Battery Management System (BMS) that provides warnings and protections against overvoltage, undervoltage, overcurrent, short circuit, high temperature, and low temperature conditions. Refer to the table below for the triggering and recovery conditions of each warning and protection.

High Voltage Disconnect (> 58.8V Battery Voltage, > 4.15 Cell Voltage)

If an individual cell voltage exceeds a prescribed threshold during charging, the BMS will prevent a charge current from continuing. Discharge is always allowed under this condition. If the batteries have not been balanced for a long time, high voltage disconnect could occur at a lower voltage. The batteries will be rebalanced after recharge.

Low-Voltage Disconnect (< 35.28V Battery Voltage, <2.52 Cell Voltage)

If an individual cell falls below a prescribed threshold during discharge, the BMS will prevent further discharge. Although the battery is in “low voltage disconnect” mode, it will still allow a charging current. Battery operation will resume after charging.

High Temperature Charging and Discharging

The BMS will not allow a charging current if the internal temperature of the battery has reached 150°F (65°C). The battery will charge once the temperature is below 150°F (65°C). The BMS will not allow a discharging current if the internal temperature of the battery has reached 150°F (65°C). The battery will turn on once the temperature is below 150°F (65°C).

Low Temperature Operation

The BMS will not allow a charging current under -4°F (-20°C). Charging is allowed at > -4°F (-20°C). Discharging is allowed down to -4 °F (-20°C). Discharge will resume when the temperature is above -4 °F (-20°C).

High Current Discharge Surges

The BMS will not allow a current that exceeds 500 (+/- 5%) Amps for the 48V210Ah or 150A for the 48V60Ah battery for more than 60 seconds. After a high current disconnection, the battery will automatically reconnect after 60 seconds.

Short Current Discharge Surges

Our BMS has built-in short circuit protection of 1000A for 2msec. If the short circuit protection is tripped, the BMS will shut the battery down and will remain disconnected until you remove the battery cables.

Balancing Cells

A passive balancing process is activated by the BMS at the top of each charge cycle when the battery voltage exceeds 58.8 V. This ensures that all the cells remain in the same state of charge, which helps pack longevity and performance.

How to Properly Store Batteries

Please follow the tips below to ensure that the battery emerges from storage in good condition:

Charge the battery to 30% to 80% SOC.

- Disconnect the battery from the system.
- Store the battery in a well-ventilated, dry, clean area with temperatures between -4°F (-20°C) and 113°F (45°C).
- Do not expose the battery to direct sunlight, moisture, or precipitation.
- Handle the battery carefully to avoid sharp impacts or extreme pressure on the battery housing.
- Charge the battery at least once every 3 to 6 months to prevent it from over-discharge.
- Fully charge the battery when it is taken out of storage.

How to Maintain the Batteries

Inspection

Please perform regular inspections following the steps below:

- Examine the external appearance of the battery. The housing and terminals of the battery shall be clean, dry, and free of corrosion.
- Check battery cables and connections. Replace any damaged cables and tighten any loose connections.

 In certain application scenarios, corrosion may occur around the terminals. Corrosion can cause increased resistance and poor contact. It is recommended to regularly apply insulation grease to each terminal. Insulation grease can form a moisture-resistant seal and protect the terminals from corrosion.

Cleaning

Please clean the battery at regular intervals following the steps below:

- Disconnect the battery from the system.
- Clear the leaves and debris from the battery.
- Clean the battery with a soft, lint-free cloth. The cloth can be dampened with water or mild soap and water if the battery is extremely dirty.
- Dry the battery with soft, lint-free cloth.
- Keep the area around the battery clean.
- Reconnect the battery to the system.

Checking Voltage

Please check the battery voltage periodically to assess battery health. If the battery is unable to be activated with a charge/discharge current greater than 1A or the battery is activated with a resting voltage below 35 V, the battery may have been severely over-discharged due to self-discharge or parasitic loads. Please stop using the battery until the fault can be corrected and the battery can be charged.

How to Properly Recycle and Dispose of the Batteries

1. Make sure all loads are removed from your system before removing the batteries. Once the batteries are removed cover the terminals using electrical tape. Check the cables and connectors.
2. Visit www.earth911.com or www.call2recycle.org/locator to find a drop off location. Be sure to call ahead of time to confirm that the drop-off location is still accepting materials.
3. Give us a call if you are having any trouble finding a drop-off location and we can help you find one.

Limited Warranty

Solid State Marine Inc. (SSM) warrants its batteries from any defects in materials and workmanship for 8 years from the date of purchase. If you have a quality issue with a product, we will repair or replace any defective battery at no charge. Contact our customer service department with proof of purchase to arrange for repairs.

This warranty does not cover damage resulting from misuse, accidents, alterations, improper installation, or normal wear and tear. This warranty is void if the product is modified in any way.

The warranty is limited to the original purchaser and is non-transferable.

Return Policy

SSM offers 30-day money back guarantee. Returns of undamaged batteries may be issued full refunds less a 20% restocking fee. To be eligible for a return, your item must be in the same condition that you received it, unused and in its original packaging. You'll also require proof of purchase. Please note voltages and internal BMS data will be checked for any usage.

Customer Service

SSM offers free lifetime technical support & free battery analysis. If you have a quality issue with a product, please contact us at support@solidstatemarine.com to help diagnose the problem. If a product does not meet our high-quality standards, then we will issue you a replacement component or fix the original at no additional cost. SSM is not responsible for return shipping.

Return Shipping

In the event your Battery has to be returned to SSM for any reason, it must be shipped in an approved shipping box. If you did not save the original packaging, SSM will provide packaging to return the Battery. The cost of this service for Batteries weighing up to 79 lbs. will be \$25 plus the actual shipping charges to the destination. For batteries weighing more than 79 lbs., please contact SSM for a box and shipping quote.

Product Specifications

	SSM27 48V60Ah	SSM8D 48V120Ah	SSM8D- 48V210Ah
Battery Type:	Solid State	Solid State	Solid State
Voltage:	48 V	48 V	48 V
Rated Capacity:	60 Ah	120 Ah	210 Ah
Power:	3024 Wh	6048 Wh	10584 Wh
Charge Voltage:	58.1 V	58.1 V	58.1 V
Fast Charge Current:	60 A	120 A	210 A
Peak Discharge Current: 60 s	120 A (BMS)	240 A (BMS)	500 A (BMS)
Continuous Discharge Current:	60 A	120 A	210 A

TEMPERATURE	
High Temperature Cutoff	65°C (BMS)
Charge Temperature Range	-4°F~150°F (0°C- 65°C)
Discharge Temperature Range	-4°F~150°F (-20°C - 65°C)
Storage Temperature	32°F~113°F (0C- 45°C)
OTHER	
Connection Method	Series and Parallel (2S4P)
Communication Protocol	Optional NMEA 2000
Terminal Bolt Size	M8
Recommended Terminal Torque	10 – 12 Nm
Housing Material	ABS
Protection Rating	IP67
Accessories	Long Terminal Bolts (2): M8
Testing	UN38.3, UL1642
Discharge Cycles	3000
Warranty	Material and Workmanship: 8 years, 5 year free replacement

Mechanical Specifications

Model	SSM27A – 48V60Ah	SSM8D- 48V120Ah	SSM8D-48V210Ah
BIC Group	27	8D	8D*
Dimensions	11.61 x 7.99 x 10.76	20.47 x 10.01 x 9.7	20.47 x 11.01 x 9.7
Weight	31 Lbs.	60 Lbs.	105 Lbs.

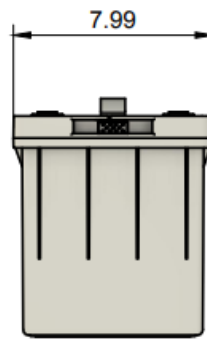
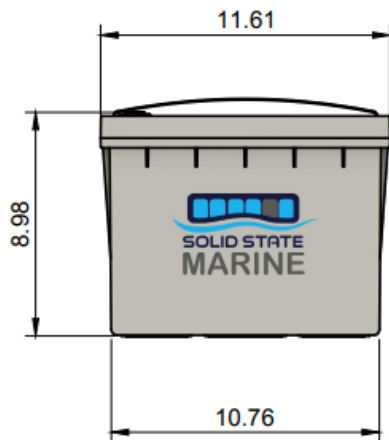

Group 27

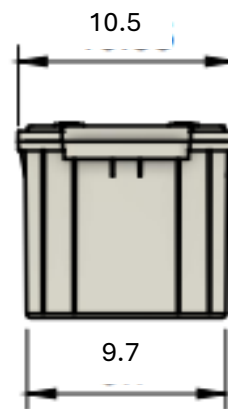
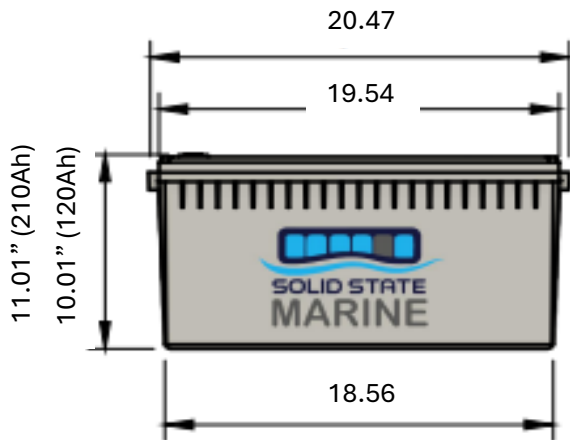

Group 8D